



User Manual

SG800

SG900

SG1000

About Microinverter

This microinverter system is composed of a group of Microinverters that convert direct current (DC) into alternating current (AC) and feeds it into the public grid. The system is designed for the incorporation of one Microinverter for two photovoltaic modules. Each Microinverter works independently that guarantees the maximum power generation of each photovoltaic module. This setup enables user to control the production of a single photovoltaic module directly, consequently improving the flexibility and reliability of the system.

About the Manual

This manual contains important instructions for the SG800 / SG900 / SG1000 Microinverter and must be read in its entirety before installing or commissioning the equipment. For safety, only qualified technician, who has received training or has demonstrated skills can install and maintain this Microinverter under the guide of this document.

Disclaimer

Our company shall not be liable for any of the following situations and the resulting consequences:

1. Equipment damage caused by force majeure such as earthquakes, floods, wars, etc.
2. The operating, installation, and usage environment, as well as self - provided materials and tools, do not meet the requirements (including operation not under the conditions specified in the manual, the installation and usage environment not conforming to standards, and self provided materials and tools not meeting the requirements of relevant laws, regulations, and standards);
3. Operations by unqualified personnel (installation and use of equipment by unqualified personnel);
4. Violation of operating regulations (failure to operate in accordance with the operation instructions and safety warnings in the product documentation, unauthorized disassembly, modification of products, or modification of software code);
5. Improper transportation and storage (damage caused by you or a third - party transportation you commissioned, and damage caused by storage conditions not meeting the requirements of the product documentation);
6. Faults of you or a third party (damage caused by negligence, intent, gross negligence. Improper operation, etc. not attributable to our company).

Contents

1. Important Notes	4
1.1 Product Range	4
1.2 Target Group	4
1.3 Symbols Used	4
2. About Safety	4
2.1 Important Safety Instructions	4
2.2 Explanation of Symbols	5
2.3 Radio Interference Statement	6
3. About Product	7
3.1 About 4 in 1 Unit	7
3.2 Highlights	7
3.3 Terminals Introduction	7
3.4 Dimension(mm)	7
4. About Function	8
4.1 Work Mode	8
5. About Installation	9
5.1 Accessories	9
5.2 Installation Precaution	9
5.3 Space Distance Required	10
5.4 Preparation	10
5.5 Pre-installation	11
5.6 Installation Steps	12
6. Troubleshooting	16
6.1 Troubleshooting List	16
6.2 Status LED Indicator	18
6.3 On-site Inspection (For qualified installer only)	19
6.4 Routine Maintenance	19
6.5 Replace Microinverter	20

7. Decommissions	21
7.1 Decommissions	21
7.2 Storage and Transportation	21
7.3 Disposal	22
8. Technical Data	22
8.1 DC Input	22
8.2 AC Output	23
8.3 Efficiency, Safety and Protection	23
8.4 Mechanical Data	23
8.5 Features	24
Appendix 1:	24
Installation Map	24
Appendix 2:	25
WIRING DIAGRAM – 230VAC SINGLE PHASE:	25
WIRING DIAGRAM – 230VAC / 400VAC THREE PHASE:	26
WIRING DIAGRAM-120V/240V AC SPLIT PHASE	27
WIRING DIAGRAM-120V/208V AC THREE PHASE	28

1. Important Notes

1.1 Product Range

This manual describes the assembly, installation, commissioning, maintenance and failure search of the following model of SOLENZO Microinverter:

- SG800 ● SG900
- SG1000



**Note: "800" means 800VA, "900" means 900VA, "1000" means 1000VA.*

1.2 Target Group

This manual is only for qualified technician, who has been trained or has demonstrated skills can install and maintain this Microinverter under the guide of this document for safety purpose.

1.3 Symbols Used

The safety symbols in this user manual are show as below.

Symbol	Usage
	<p>Indicates a hazardous situation that can result in deadly electric shock hazards, other serious physical injury, or fire hazards.</p>
	<p>Indicates directions which must be fully understood and followed in entirety in order to avoid potential safety hazards including equipment damage or personal injury.</p>
	<p>Indicates this points out that the described operation must not be carried out. The reader should stop, use caution and fully understand the operations explained before proceeding.</p>

2. About Safety







2.1 Important Safety Instructions

The SG800 / SG900 / SG1000 Microinverter is designed and tested according to international safety requirements. However, certain safety precautions must be taken when installing and operating this inverter. The installer must read and follow all instructions, cautions and warnings in this installation manual.

<p>➤ All operations including transport, installation, start-up and maintenance, must be carried out by qualified, trained personnel.</p>
<p>➤ Before installation, check the unit to ensure free of any transport or handling damage, which could affect insulation integrity or safety clearances. Choose installation location carefully and adhere to specified cooling requirements. Unauthorized removal of necessary protections, improper use, incorrect installation and operation may lead to serious safety and shock hazards or equipment damage.</p>
<p>➤ Before connecting the Microinverter to the power distribution grid, contact the local power distribution grid company to get appropriate approvals. This connection must be made only by qualified technical personnel. It is the responsibility of the installer to provide external disconnect switches and Over current Protection Devices (OCPD).</p>
<p>➤ Only one photovoltaic module can be connected to one input of the inverter. Do not connect batteries or other sources of power supply. The inverter can be used only if all the technical characteristics are observed and applied.</p>
<p>➤ Do not install the equipment in adverse environment conditions such as flammable, explosive, corrosive, extreme high or low temperature, and humid. Do not use the equipment when the safety devices do not work or disabled.</p>
<p>➤ Use personal protective equipment, including gloves and eye protection during the installation.</p>
<p>➤ Inform the manufacturer about non-standard installation conditions.</p>
<p>➤ Do not use the equipment if any operating anomalies are found. Avoid temporary repairs.</p>
<p>➤ All repairs should be carried out using only qualified spare parts, which must be installed in accordance with their intended use and by a licensed contractor or authorized SOLENZO service representative.</p>
<p>➤ Liabilities arising from commercial components are delegated to their respective manufacturers.</p>
<p>➤ Anytime the inverter has been disconnected from the public network, please be extremely caution as some components can retain charge sufficient to create a shock hazard. Prior to touching any part of the inverter please ensure surfaces and equipment are under touch safe temperatures and voltage potentials before proceeding.</p>
<p>➤ SOLENZO accepts No liability for damage from incorrect or improper operation.</p>
<p>➤ Electrical Installation & Maintenance shall be conducted by licensed electrician and shall comply with Local Wiring Rules.</p>

2.2 Explanation of Symbols

Symbol	Usage
	<p>Treatment</p> <p>To comply with European Directive 2002/96/EC on waste Electrical and Electronic Equipment and its implementation as national law, electrical equipment that has reached the end of its life must be collected separately and returned to an approved recycling facility. Any device no longer required must be returned to an authorized dealer or approved collection and recycling facility.</p>

	<p>Caution Do not come within 8 inches (20cm) of the microinverter for any length of time while it is in operation.</p>
	<p>Danger of high voltages Danger to life due to high voltage in the microinverter.</p>
	<p>Beware of hot surface The inverter can become hot during operation. Avoid contact with metal surfaces during operation.</p>
	<p>CE mark The inverter complies with the requirements of the Low Voltage Directive for the European Union.</p>
	<p>Read manual first Please read the installation manual first before installation, operation and maintenance.</p>
	<p>Environmental labeling Pay attention to environmental protection</p>

2.3 Radio Interference Statement

This microinverter has been tested and found to comply with the limits for CE EMC, which can provide reasonable protection against harmful energy. However, if not installed according to the instructions, the microinverter may cause harmful interference to radio equipment. There is no guarantee that the interference will not occur in a particular installation.

To confirm that the radio or television reception is interfered by this equipment, you can turn the equipment off and on. If this equipment does cause harmful interference to the radio or television equipment, please try to correct the interference by one or more of the following measures.

- 1) Relocate the receiving antenna.
- 2) Increase the separation between the microinverter and the receiving antenna.
- 3) Place the shield between the microinverter and the receiving antenna, such as metal/ concrete roof.
- 4) Contact your dealer or an experienced radio/TV technician for help.

3. About Product

3.1 About 2 in 1 Unit

“The world’s First Daisy-Chain 2 in 1 Unit Microinverter” with extremely wide DC input operating voltage range (22-60V) and low start-up voltage (22V only).

SOLENSO 2 in 1 unit Microinverter SG800 / SG900 / SG1000 is the perfect selection for PV system with uneven number of panels with world's NO.1 CEC weighted efficiency- 96.5%.

3.2 Highlights

- Maximum output power up to 800VA/900VA/1000VA; Adapted to 60 & 72 cells PV panels.
- CEC weighted efficiency 96.5%.
- Static MPPT efficiency 99.90%;
- Power factor (adjustable) 0.8 leading.....0.8 lagging.
- External antenna for stronger communication with DTU.
- High reliability: NEMA6 (IP67) enclosure; 6000V surge protection.
- Highest working altitude 2000 meters.

3.3 Terminals Introduction

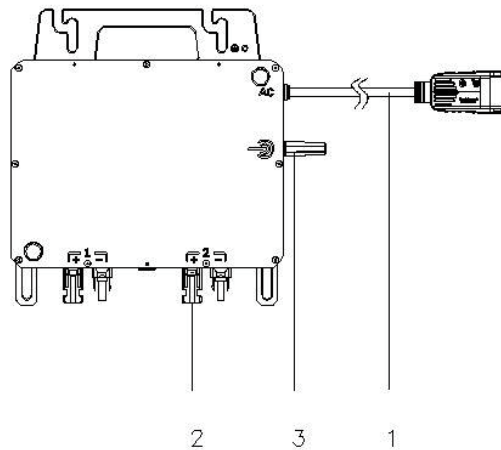

Object	Description
1	AC Connector
2	DC Connectors
3	Antenna

3.4 Dimension(mm)

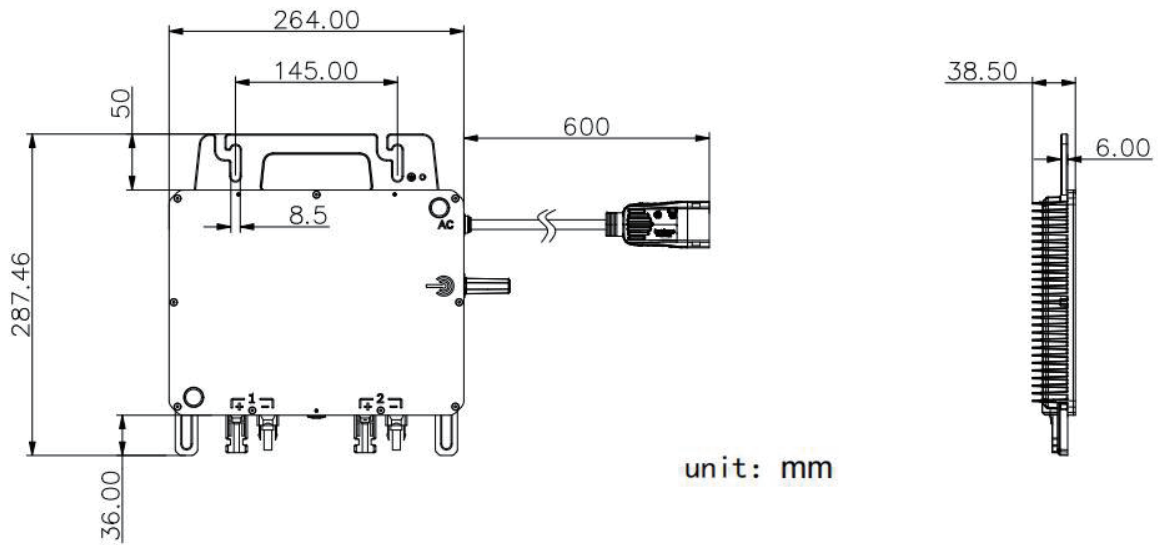

4. About Function

4.1 Work Mode

Normal: Under this mode, Microinverter is operating normally and converting DC power into AC power to support the house loads and feed in to Public Grid.

Zero Export Control: Under this mode Microinverter's generation is limited based on the current house loads, there will be no extra power feed in to the Public Grid.

Standby: There are several circumstances that Microinverter will stay in Standby mode:

- The current condition is contradicted with Microinverter operating requirement.
- No house loads or the Export control value has been set as "0" on the DTU under the Zero Export Control mode.

5. About Installation

5.1 Accessories

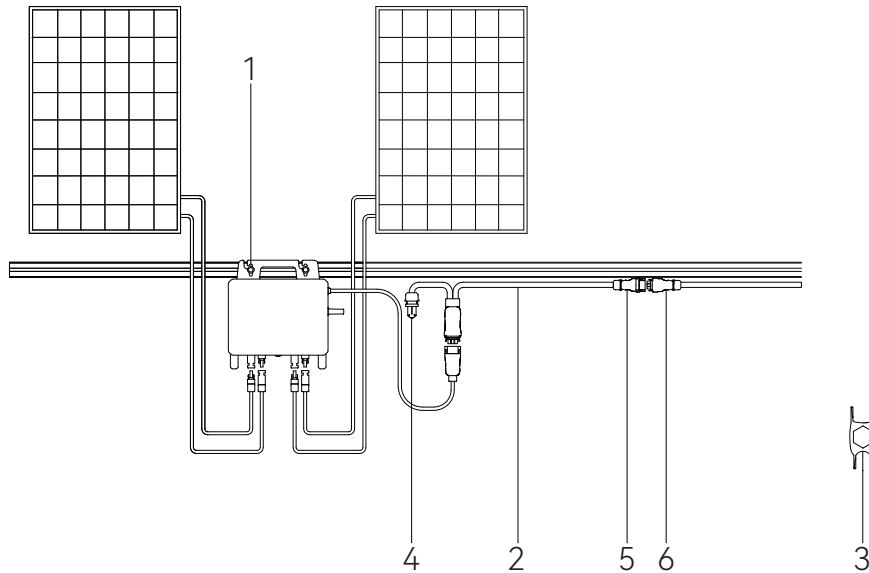

Item	Description
1	M8*25 screws
2	AC Bus Cable, 12/10 AWG Cable (SB36T2G12B)
3	AC Connector Unlock Tool (SFCUT24A)
4	AC Bus End Cap, IP67 (SNEC24B)
5	AC Female Connector (SNEC24B)
6	AC Male Connector (SNMC24B)

**Note: All accessories above are not included in the package, and need to be purchased separately. Please contact our sales representative for the price. (M8 screws need to be prepared by installer-self.)*

5.2 Installation Precaution

Please install the Microinverter and all DC connections under the PV module to avoiding direct sunlight, rain exposure, snow layup, UV etc. Allow a minimum of 2 cm of space around the microinverter enclosure to ensure ventilation and heat dissipation.

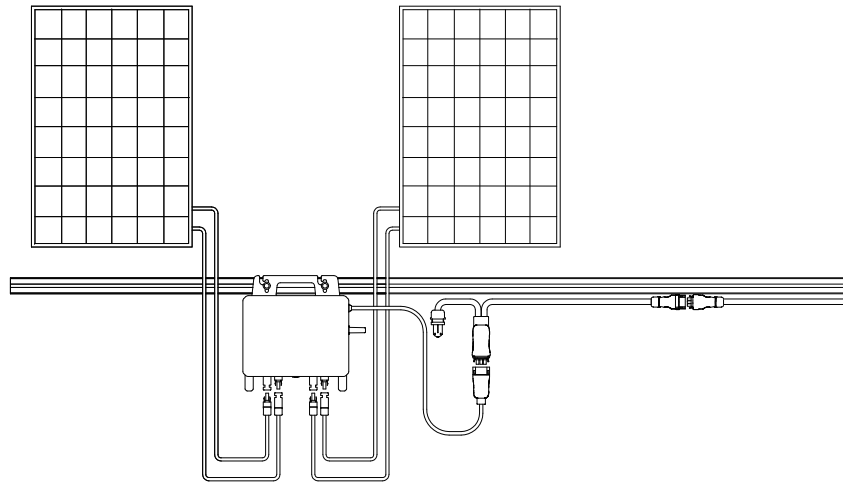

**Note: For some countries the DTU will be required to meet the local grid regulation (e.g. G98/99 for UK etc.)*

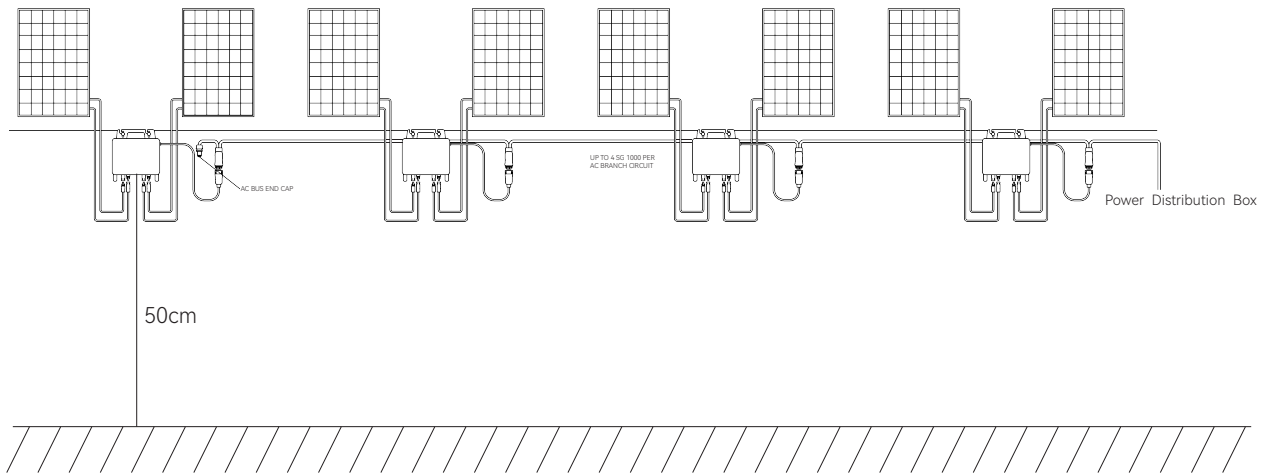

5.3 Space Distance Required

If the microinverters are installed on a concrete roof or steel roof, the communication with the DTU may be slightly affected. Under such installation conditions, it is better for the microinverters to be installed 50cm above the roof. Otherwise, more DTUs may be required to ensure the communication quality between the DTUs and the microinverters







5.4 Preparation



Installation of the equipment is carried out based on the system design and the place in which the equipment is installed.

-  The installation must be carried out with the equipment disconnected from the grid (power disconnect switch open) and with the photovoltaic modules shaded or isolated.
-  Referring to the Technical Data to make sure the environmental conditions fit the microinverter's

requirement (degree of protection, temperature, humidity, altitude, etc.)

-  To avoid power de-rating due to an increase in the microinverter internal temperature, do not expose it to direct sunlight.
-  To avoid overheating, always make sure the air flow around the inverter is not blocked.
-  Do not install in places where gasses or flammable substances may be present.
-  Avoid electromagnetic interference that can compromise the correct operation of electronic equipment.

When choosing the position of installation, comply with the following conditions:

-  Install only on structures specifically conceived for photovoltaic modules (supplied by installation technicians).
-  Install Microinverter underneath of the photovoltaic modules to make sure it works in the shadow. If this condition cannot be met, might trigger the inverter production de-rating.

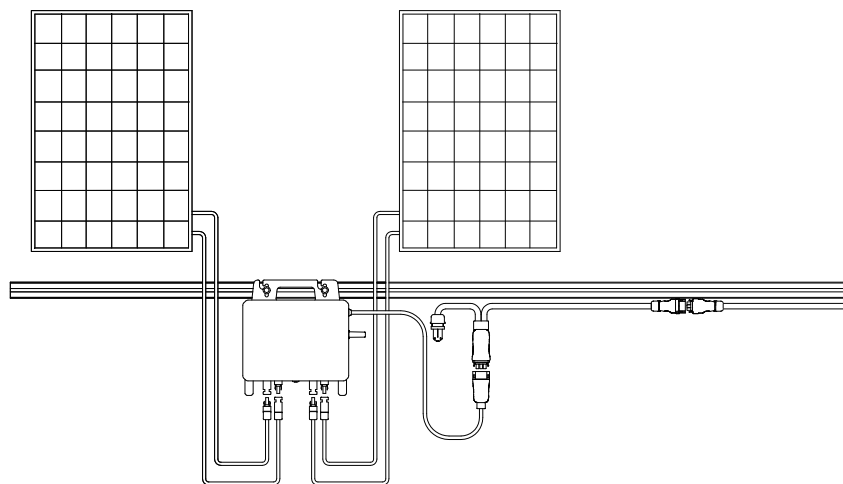

Fig.1 Installation position of microinverter

5.5 Pre-installation

- A) Plan the cable length to make the bus cable aligned with each PV module.
- B) Install the AC Female Connector and AC Male Connector :
 - ✓ Prepare a suitable length of AC cable and strip the end at the corresponding position as required.



- ✓ Insert the cable slot into the cover and ensure that the L, N, and PE wires are in their correct positions, then tighten the screws.

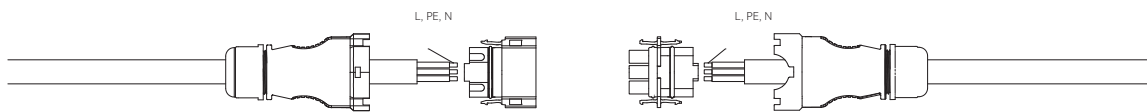

- ✓ Screw the AC bus end cap.

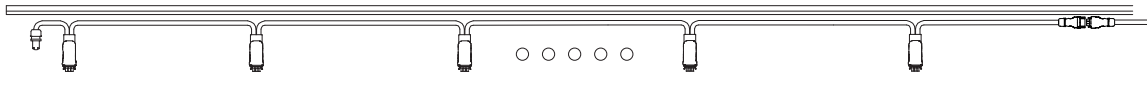

5.6 Installation Steps

Step 1. Fix Microinverter on the Rail

- Mark the approximate center of each panel on the frame.
- Fix the screw on the rail.
- Hang the microinverter on the screw (shown as picture below), and tighten the screw. The silver cover side of the Microinverter should be facing the panel.

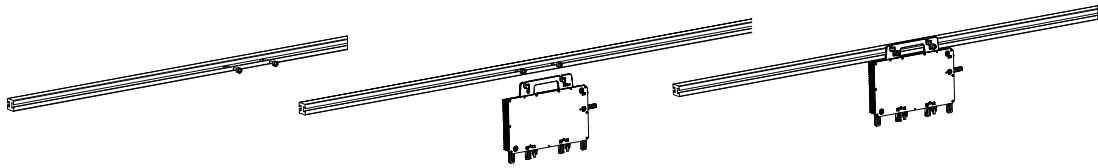

**Note: Please install the microinverter at least 50cm above the ground/roof for better communication with SOLENSE DTU.*

Step 2. Complete the AC Connection

A) Attach the AC bus cable with the mounting rail, and fix the cable with tie wraps.



B) Push the AC connector of the microinverter to the trunk cable connector until you hear “click”.

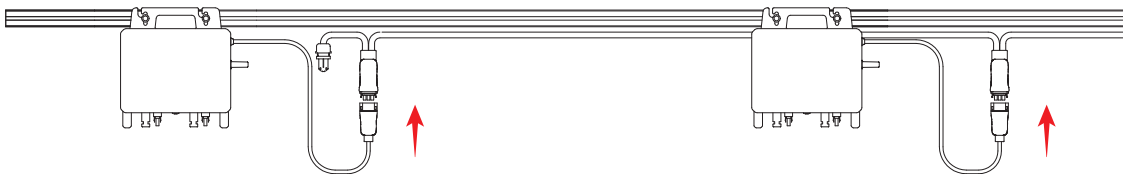

**Note: Under the circumstances that need to remove the inverter AC cable from bus port, please use the AC connector unlock tool and insert the tool into the side of AC port.*

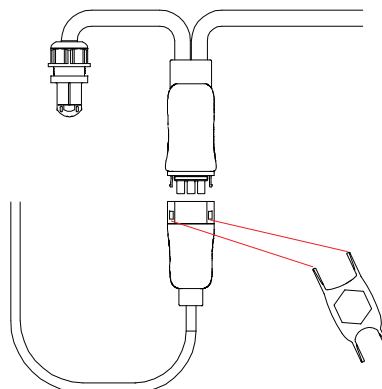

Step 3. Install AC End Cable

A) Prepare the AC end cable with the proper length, and insert one side of the cable into the cap. Match the L, N and Ground line into the slot accordingly. Tighten the screws, and then tighten the cap back to the port. Plug the upper cover back to the bus connector.

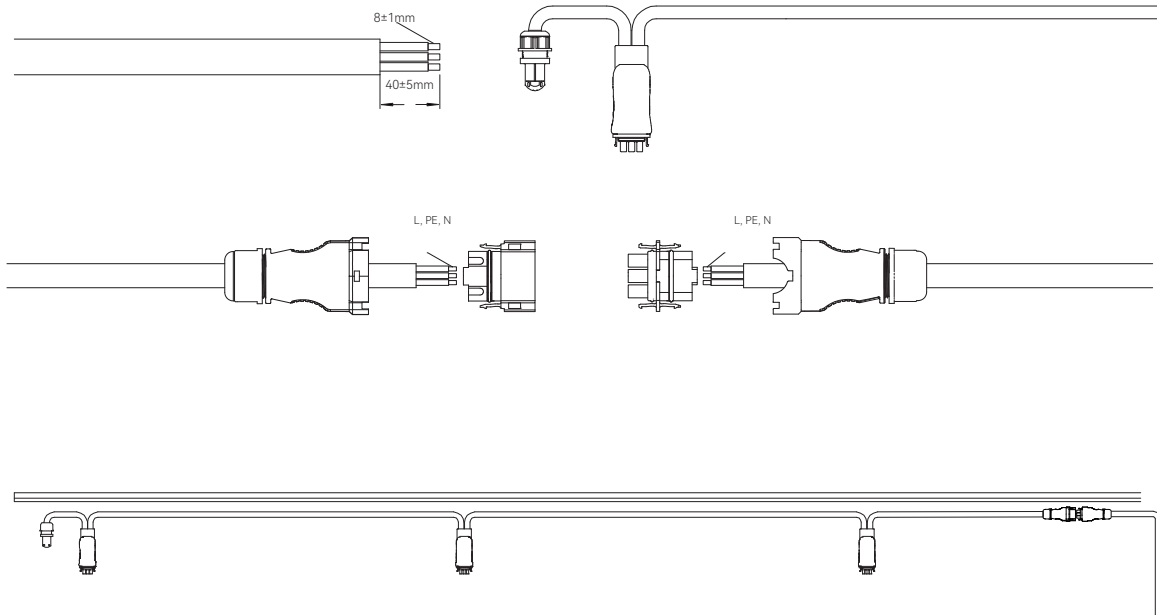

B) Connect the other side of the AC end cable to the distribution box, and wire it to the local grid network.

Step 4. Create an Installation Map

A) Peel the removable serial number lable from each microinverter (The position of the label is shown as below).

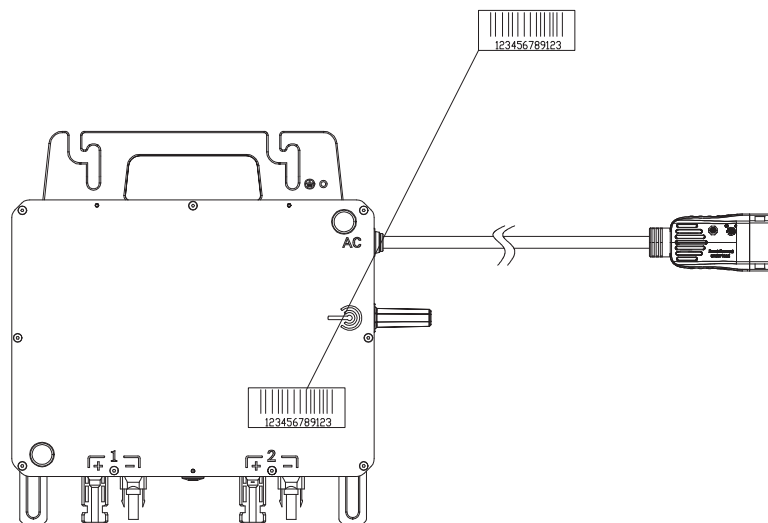

B) Affix the serial number label to the respective location on the installation map.

To sheet _____ ↑

Solense		Solense Microinverter Installation Map											Region: Europe 2024V1.0			
Please Make N for North 		Panel type: Azimuth: Tilt: Sheet ___ of ___						Customer Information:					DTU Serial Number			
COLUMN	1	2	3	4	5	6	7	8	9	10	11	12	13	14	15	16
ROW	A	B	C	D												
To sheet _____ ↑																
To sheet _____ ↓																

Step 5. Connect PV Modules

- A) Mount the PV modules above the microinverter.
- B) Connect the PV modules' DC cables to the DC input side of the microinverter.

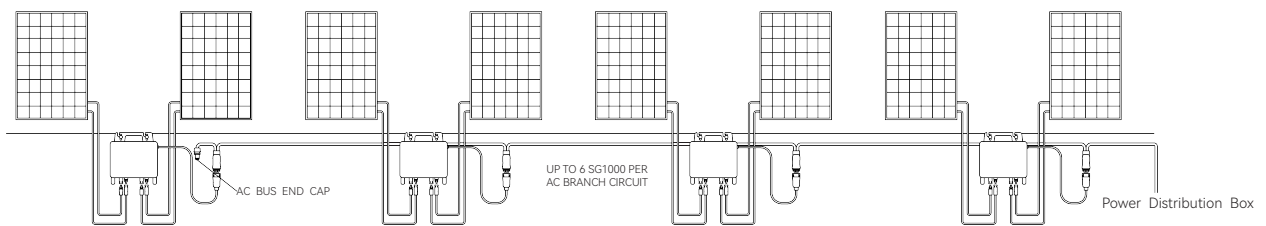

Step 6. Energize the System

- A) Turn on the AC breaker of the branch circuit.
- B) Turn on the main AC breaker of the house. Your system will start to generate power after about two-minute wait time.

Step 7. Set Up the Monitoring System

Refer to the [DTU User Manual](#) or [DTU Quick Installation Guide](#), and [Quick Installation Guide for SOLENSE Online Registration](#) to install the DTU and set up the monitoring system.

6. Troubleshooting

6.1 Troubleshooting

Alarm Name	Suggestion
Over temperature protection	<ol style="list-style-type: none"> 1. Check the ventilation and ambient temperature at the microinverter installation position. 2. If the ventilation is poor or the ambient temperature exceeds the limit, improve the ventilation and heat dissipation. 3. If both the ventilation and ambient temperature meet the requirements, contact your dealer or SOLENZO technical support.
Grid configuration parameter error	<ol style="list-style-type: none"> 1. Check if the grid configuration parameter is correct and upgrade again. 2. If the fault still exists, contact your dealer or SOLENZO technical support.
Software error code	<ol style="list-style-type: none"> 1. If the alarm occurs accidentally and the microinverter can still work normally, no special treatment is required. 2. If the alarm occurs frequently and cannot be recovered, contact your dealer or SOLENZO technical support.
Firmware error	<ol style="list-style-type: none"> 1. Check if the firmware is correct and upgrade again. 2. Check the communication between DTU and SOLENZO monitoring system, the communication between DTU and microinverter. Then try again. 3. If the fault still exists, contact your dealer or SOLENZO technical support.
Offline	<ol style="list-style-type: none"> 1. Please make sure that the microinverter works normally. 2. Check the communication status between the DTU and SOLENZO monitoring system or between the DTU and the microinverter. If the communication is poor, try to make some improvements. 3. If the alarm occurs frequently and cannot be recovered, contact your dealer or SOLENZO technical support.
Grid overvoltage	<ol style="list-style-type: none"> 1. If the alarm occurs accidentally, the grid voltage may be abnormal temporarily. The microinverter can recover automatically after grid voltage becomes normal. 2. If the alarm occurs frequently, check whether the grid voltage is within the acceptable range. If no, contact the local power operator or change the grid overvoltage protection limit via SOLENZO monitoring system with the consent of the local power operator.
10 min value grid overvoltage	<ol style="list-style-type: none"> 1. If the alarm occurs accidentally, the grid voltage may be abnormal temporarily. The microinverter can recover automatically after grid voltage becomes normal. 2. If the alarm occurs frequently, check whether the grid voltage is within

	the acceptable range. If no, contact the local power operator or change the grid overvoltage protection limit via SOLENSE monitoring system with the consent of the local power operator.
Grid undervoltage	<ol style="list-style-type: none"> 1. If the alarm occurs accidentally, the grid voltage may be abnormal temporarily. The microinverter can recover automatically after grid voltage becomes normal. 2. If the alarm occurs frequently, check whether the grid voltage is within the acceptable range. If no, contact the local power operator or change the grid overvoltage protection limit via SOLENSE monitoring system with the consent of the local power operator. 3. If the fault still exists, check the AC switch or AC wiring.
Grid overfrequency	<ol style="list-style-type: none"> 1. If the alarm occurs accidentally, the grid frequency may be abnormal temporarily. The microinverter can recover automatically after grid frequency becomes normal. 2. If the alarm occurs frequently, check whether the grid frequency is within the acceptable range. If no, contact the local power operator or change the grid overvoltage protection limit via SOLENSE monitoring system with the consent of the local power operator.
Grid underfrequency	<ol style="list-style-type: none"> 1. If the alarm occurs accidentally, the grid frequency may be abnormal temporarily. The microinverter can recover automatically after grid frequency becomes normal. 2. If the alarm occurs frequently, check whether the grid frequency is within the acceptable range. If no, contact the local power operator or change the grid overvoltage protection limit via SOLENSE monitoring system with the consent of the local power operator.
Rapid grid frequency change rate	<ol style="list-style-type: none"> 1. If the alarm occurs accidentally, the grid frequency may be abnormal temporarily. The microinverter can recover automatically after grid frequency becomes normal. 2. If the alarm occurs frequently, check whether the grid frequency change rate is within the acceptable range. If no, contact the local power operator or change the grid frequency change rate limit via SOLENSE monitoring system with the consent of the local power operator.
Power grid outage	Please check whether there is a power grid outage.
Grid disconnection	Please check whether the AC switch or AC wiring is normal.
Island detected	<ol style="list-style-type: none"> 1. If the alarm occurs accidentally, the grid voltage may be abnormal temporarily. The microinverter can recover automatically after grid voltage becomes normal. 2. If the alarms occur frequently on all the microinverters in your station, contact the local power operator to check whether there is a grid island. 3. If the alarm still exists, contact your dealer or SOLENSE technical support.
Input port overvoltage	1. Please make sure that the PV module open-circuit voltage is less than or equal to the maximum input voltage.

	2. If the PV module open-circuit voltage is within the normal range, contact your dealer or SOLENZO technical support.
Input port undervoltage	1. Please make sure that the PV module open-circuit voltage is less than or equal to the maximum input voltage. 2. If the PV module open-circuit voltage is within the normal range, contact your dealer or SOLENZO technical support.
Port No input	1. Please confirm whether this port is connected to the PV module; 2. If the PV module is connected, please check the DC cable connection between this port and the PV module.
Hardware Error Code	1. If the alarm occurs accidentally and the microinverter can still work normally, no special treatment is required. 2. If the alarm occurs frequently and cannot be recovered, contact your dealer or SOLENZO technical support.

6.2 Status LED Indicator

The LED flashes five times at start up. All green flashes (1s gap) indicate normal start up.

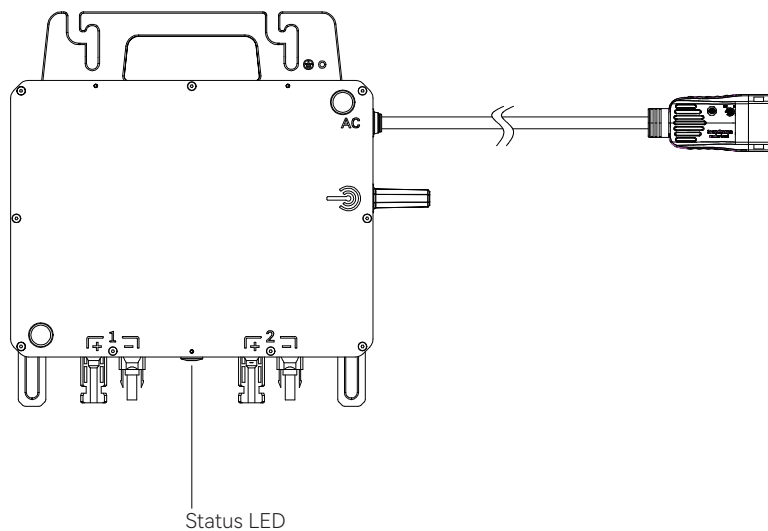

(1) Start-up Process

- ✓ Flashing green five times (0.3s gap): Start-up success
- ✓ Flashing Red five times (0.3s gap): Start-up failure

(2) Run Process

- ✓ Flashing Fast Green (1s gap): Producing power.
- ✓ Flashing Slow Green (2s gap): Producing power but one input is abnormal.
- ✓ Flashing Slow Green (4s gap): Producing power but there is no communication with DTU.
- ✓ Flashing Red (1s gap): Not producing power AC grid invalid (Voltage or frequency out of range).

- ✓ Flashing Red (0.5s gap): There is a fault except the abnormality of grid.

(3) Other Status

- ✓ Flashing Red and Green alternately: Firmware is corrupted.

**Note: All the faults are reported to the DTU, refer to the local APP of the DTU or SOLENZO Monitoring Platform for more information.*

6.3 On-site Inspection (For qualified installer only)

To troubleshoot an inoperable microinverter, follow the steps in the order shown.

1. Verify the utility voltage and frequency are within ranges shown in the in appendix Technical Data of this microinverter.
2. Check the connection to the utility grid. Verify utility power is present at the inverter in question by removing AC, then DC power. Never disconnect the DC wires while the microinverter is producing power. Re-connect the DC module connectors and watch for five short LED flashes.
3. Check the AC branch circuit interconnection between all the microinverters. Verify each inverter is energized by the utility grid as described in the previous step.
4. Make sure that any AC breaker are functioning properly and are closed.
5. Check the DC connections between the microinverter and the PV module.
6. Verify the PV module DC voltage is within the allowable range shown in appendix Technical Data of this manual.
7. If the problem persists, please call SOLENZO customer support.

Warning

- Do not try to repair the microinverter. If the troubleshooting fails, please contact your dealer in a timely manner.

6.4 Routine Maintenance

1. Only authorized personnel are allowed to carry out the maintenance operations and are responsible to report any anomalies.
2. Always use the personal protective equipment provided by the employer when carry out the maintenance operation.
3. During normal operation, check that the environmental and logistic conditions are correct. Make

sure that the conditions have not changed over time and that the equipment is not exposed to adverse weather conditions and has not been covered with foreign bodies.

4. DO NOT use the equipment if any problems are found, and restore the normal conditions after the fault removed.

5. Conduct an annual inspection on various components, and clean the equipment with a vacuum cleaner or special brushes.



Do not attempt to dismantle the Microinverter or make any internal repairs! In order to preserving the integrity of safety and insulation, the Microinverters are not designed to allow internal repairs!



The AC output wiring harness (AC drop cable on the Microinverter) cannot be replaced. If the cord is damaged the equipment should be scrapped.



Maintenance operations must be carried out with the equipment disconnected from the grid (power switch open) and the photovoltaic modules obscured or isolated, unless otherwise indicated.



For cleaning, do not use rags made of filamentary material or corrosive products that may corrode parts of the equipment or generate electrostatic charges.



Avoid temporary repairs. All repairs should be carried out using only genuine spare parts.



If all the microinverters connect to the DTU, the DTU can limit the output power imbalance of all the microinverters between phases to below 3.68kW if require . Please refer to “SOLENSO Technical Note Limit Phase Balance” for more details.



Each branch should provide a circuit breaker, but no need for central protection unit.

6.5 Replace Microinverter

a. How to remove the Microinverter.

- De-energize the AC branch circuit breaker.
- Remove the PV panel from the racking, and cover the panel.
- Using a meter to measure and make sure there is no current flowing in the DC wires between panel and microinverter.
- Use the DC disconnect tool to remove the DC connectors.
- Use the AC disconnect tool to remove the AC connectors.
- Un-screw the fixing screw on the top of the microinverter and remove the microinverter from the PV racking.

b. How to replace the Microinverter:

- Please record down the new Microinverter's SN.
- Please make sure the AC branch circuit breaker is off, and following the Microinverter installation steps to install the replacement unit.
- Go to the monitoring platform (if customer already registers this station online), please access the "Device List" page and find the device that you just replaced. Please click the down arrow next to the "More" on the right side of the page, and select "Replace". Input the new Microinverter's SN and click "OK" to complete the station changes.

Device Management / End Device Management

+ add import export super Edge Device Type search keyword Q						
<input type="checkbox"/>	Issuance Status	Device SN	Super Device	Product	Device Type	operate
<input type="checkbox"/>	● Not Issued	011024220015	010124210022	SG800	Micro inverter	edit replace ⋮
<input type="checkbox"/>	● Not Issued	011024220014		SG800	Micro inverter	edit replace ⋮
<input type="checkbox"/>	● Not Issued	011024220013	010124210026	SG800	Micro inverter	edit replace ⋮
<input type="checkbox"/>	● Issued	011024220011	010124210022	SG800	Micro inverter	edit replace ⋮
<input type="checkbox"/>	● Not Issued	011024220077		SG800	Micro inverter	edit replace ⋮
<input type="checkbox"/>	● Issued	011024220076	010124210098	SG800	Micro inverter	edit replace ⋮
<input type="checkbox"/>	● Issued	011024880010	010124010010	SG1000	Micro inverter	edit replace ⋮
<input type="checkbox"/>	● Issued	011024880000	010124010010	SG1000	Micro inverter	edit replace ⋮

Total 548 < 1 2 3 4 5 6 ... 55 > 10/page

7. Decommissions

7.1 Decommissions

Disconnect the inverter from DC input and AC output; remove all connection cable from the Microinverter; remove the Microinverter from the frame.

Please pack the Microinverter with the original packaging, or use the carton box that can afford 6kg weight and can be fully closed if the original packaging is no longer available.

7.2 Storage and Transportation

SOLENSO packages and protects individual components using suitable means to make the transport and subsequent handling easier. Transportation of the equipment, especially by road, must be carried out by suitable ways for protecting the components (in particular, the electronic components) from violent shocks, humidity, vibration, etc. Please dispose the packaging elements in appropriate ways to avoid unforeseen injury.

It is the customer's responsibility to examine the condition of the components transported. Once receiving the Microinverter, it is necessary to check the container for any external damage. Call the delivering carrier immediately if damage is detected. If inspection reveals damage to the inverter, contact the supplier, or authorized distributor for a repair/return determination and instructions regarding the process.

The microinverter storage temperature is -40-65°C.

7.3 Disposal

- If the equipment is not used immediately or is stored for long periods, check that it is correctly packed. The equipment must be stored in well-ventilated indoor areas that do not have characteristics that might damage the components of the equipment.
- Take a complete inspection when restarting after a long time or prolonged stop.
- Please dispose the equipment properly after scrapping, which are potentially harmful to the environment, in accordance with the regulations in force in the country of installation.

8. Technical Data

Warning

Be sure to verify the following before installing SOLENZO Microinverter System.

Verify that the voltage and current specifications of the PV module must match those of the microinverter.

The maximum open circuit voltage rating of the PV module must within the operating voltage range of the microinverter.

The maximum current rating at MPP is recommended to be equal to or less than the maximum input DC current. But the maximum short circuit current must be equal to or less than the maximum input DC short circuit current.

The output DC power of PV module is NOT recommended to exceed 1.35 times the output AC power of the microinverter. Refer to " SOLENZO Warranty Terms & Conditions " for more information.

8.1 Input Data (DC)

Model	SG800	SG900	SG1000
Commonly used module power (W)	320~540+	400~600+	400~670+
Peak power MPPT voltage range (V)	25~55		

Model	SG800	SG900	SG1000
Start-up voltage (V)	22		
Maximum input voltage (V)	65		
Maximum input current (A)	14*2	15*2	16*2
Maximum Short-circuit Current (A)	25*2		

8.2 Output Data (AC)

Rated output power (VA)	800	900	1000
Nominal output voltage (V)	220/230/240		
Nominal output voltage range (V)	230/180-275		
Nominal frequency/range (Hz)	50/45-55		
Power factor (adjustable)	>0.99 default 0.8leading-0.8lagging		
Total harmonic distortion	<3%		
Maximum units per branch (12AWG)	7/7/8	7/7/7	6/6/6
Maximum units per branch (10AWG)	10/10/11	9/9/10	8/8/9

8.3 Efficiency

CEC peak efficiency	96.5%
CEC weighted efficiency	96.5%
Nominal MPPT efficiency	99.9%
Nighttime power consumption (mW)	24

8.4 Mechanical Data

Ambient temperature range (°C)	-40 ~ +65
Dimensions (W×H×D mm)	264x290x40
Weight (KG)	3.6
Protective rating (IP)	IP67
Cooling	Natural convection-No fans

8.5 Features

Model	SG800	SG900	SG1000
Communication	Sub-1G		
Warranty	15 years standard; up to 25 years optional		
Compliance	VDE-AR-N 4105:2020, EN50549-1:2019, VFR2019, EN50549-10:2022 IEC/EN 62109-1/-2, IEC/EN-61000-6-1/-3		

**Note: Voltage and frequency ranges can be extended beyond nominal if required by the utility.*

Appendix 1:

Installation Map

To sheet _____ ↑

Solenso Microinverter Installation Map Region: Europe 2024V1.0																
Please Make N for North 		Panel type: Azimuth: Tilt: Sheet ___ of ___						Customer Information:				DTU Serial Number				
COLUMN	1	2	3	4	5	6	7	8	9	10	11	12	13	14	15	16
ROW																
A																
B																
C																
D																

To sheet _____ ↑

To sheet _____ ↓

To sheet _____ ↓

Appendix 2:

WIRING DIAGRAM – 230VAC SINGLE PHASE:

**Note: The cable used in the picture is 12 AWG, if you choose 10 AWG, it can be up to a maximum of 9 SG1000 per AC branch. Microinverters of different power tiers may be used together.*

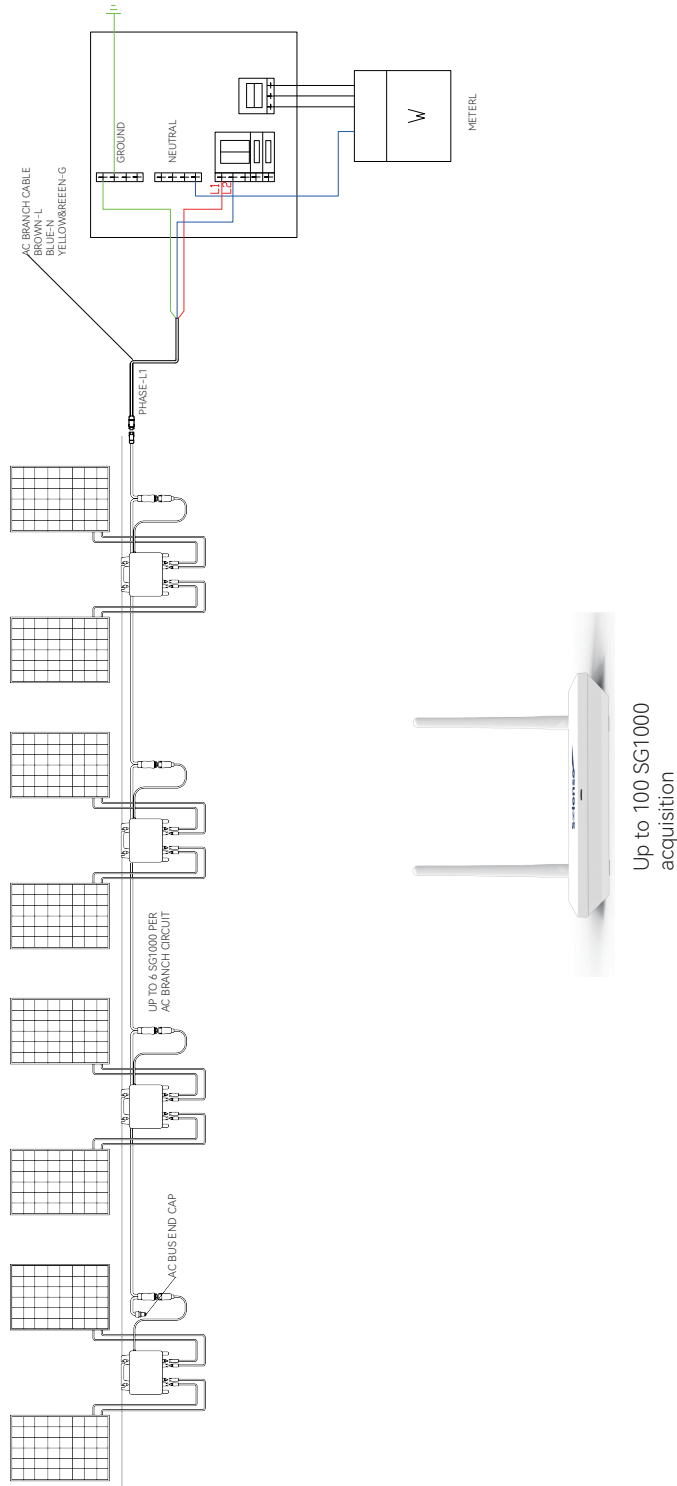

WIRING DIAGRAM – 230VAC / 400VAC THREE PHASE:

*Note: The cable used in the picture is 12 AWG, if you choose 10 AWG, it can be up to a maximum of 9 SG1000 per AC branch.
Microinverters of different power tiers may be used together.

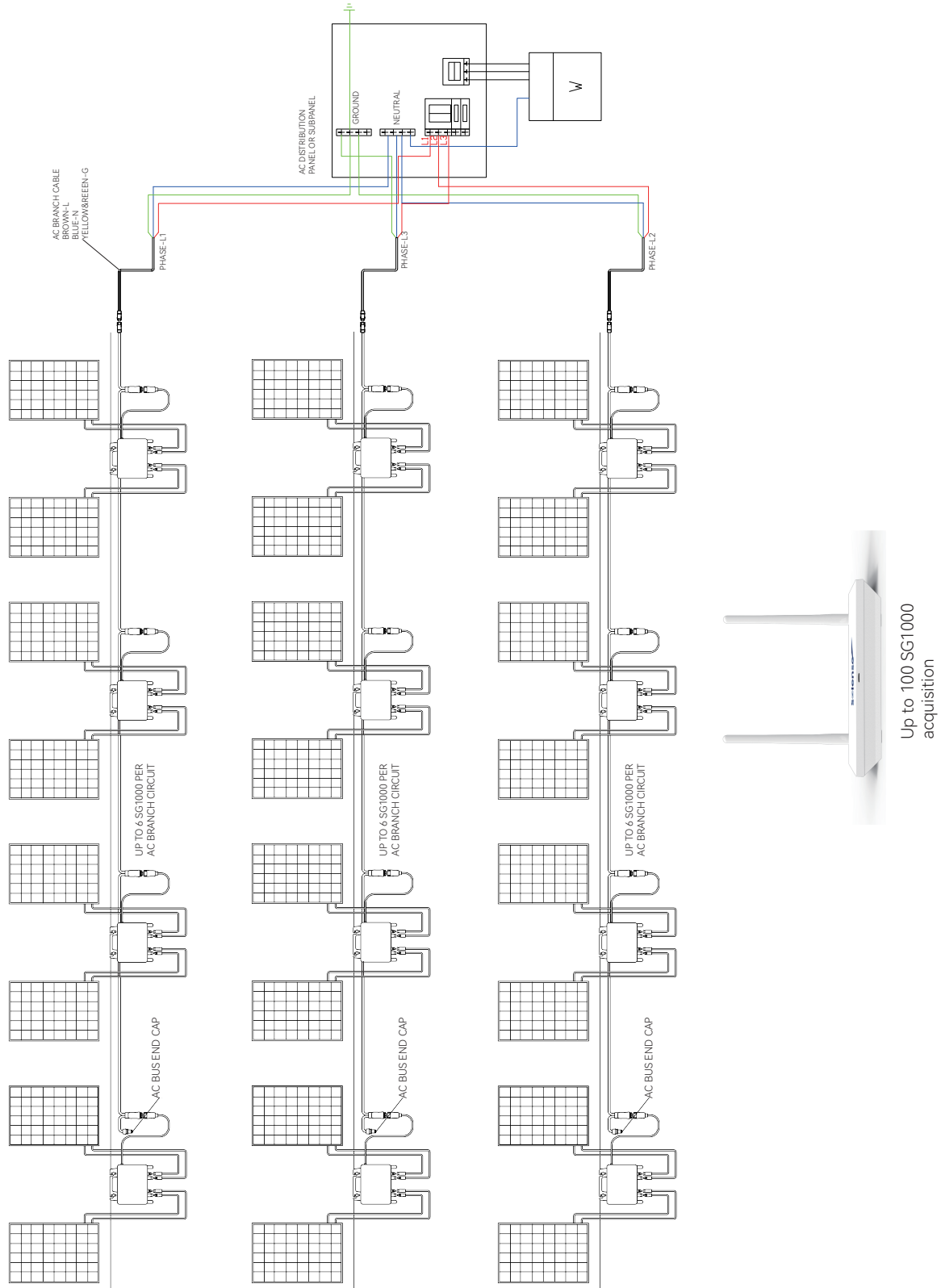

WIRING DIAGRAM-120V/240V AC SPLIT PHASE

*Note: The cable used in the picture is 12 AWG, if you choose 10 AWG, it can be up to a maximum of 9 SG1000 per AC branch.
Microinverters of different power tiers may be used together.

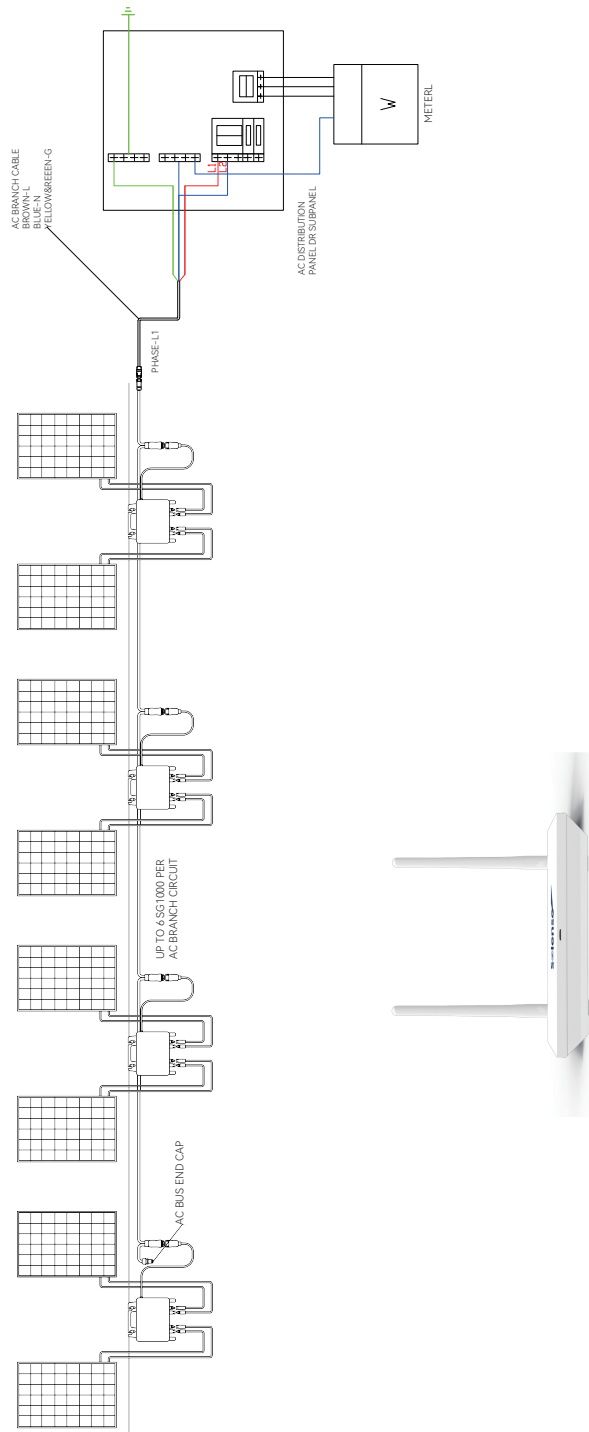

WIRING DIAGRAM-120V/208V AC THREE PHASE

*Note: The cable used in the picture is 12 AWG, if you choose 10 AWG, it can be up to a maximum of 9 SG1000 per AC branch.
Microinverters of different power tiers may be used together.

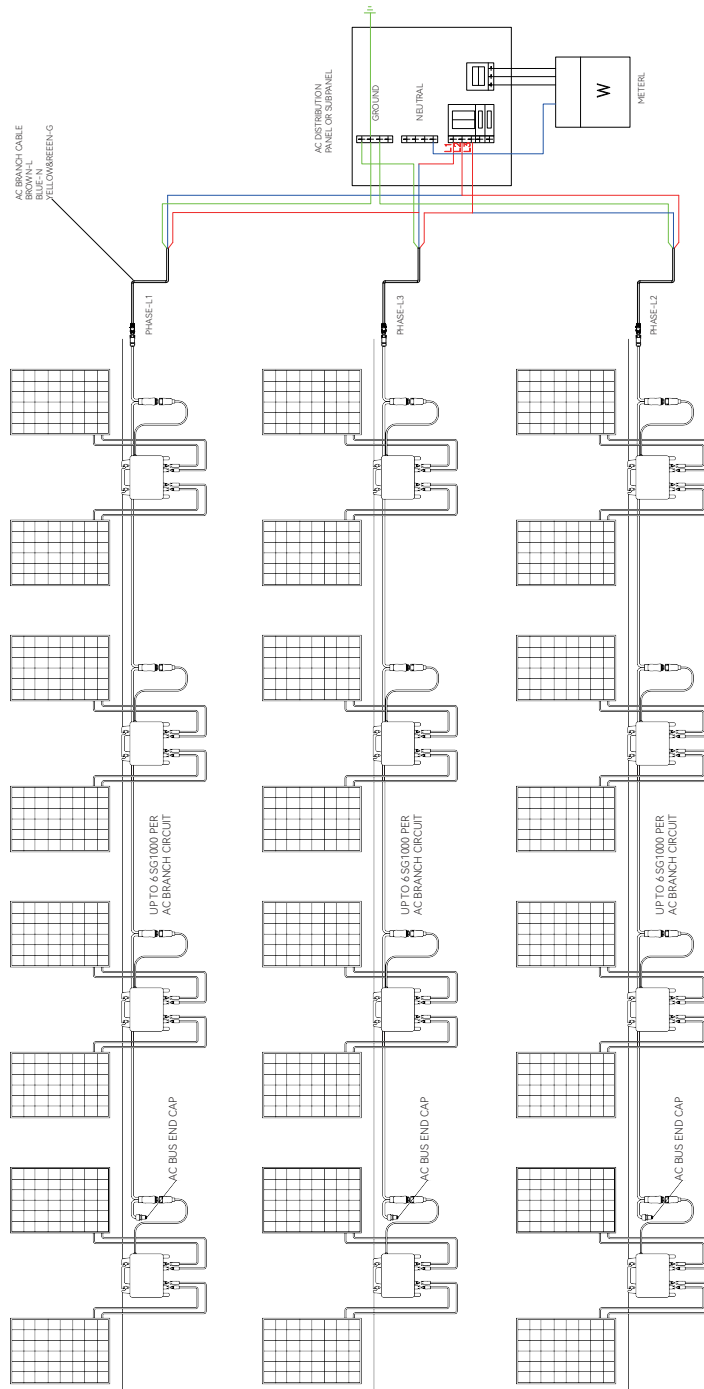

Up to 100 SG1000 acquisition